

Guide rails

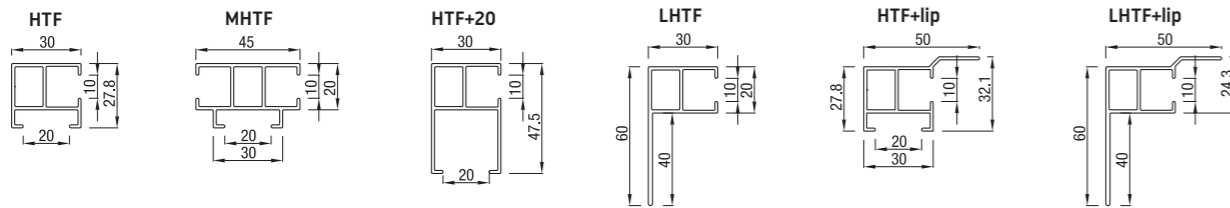

Standard casing colours

Colour closest to RAL*

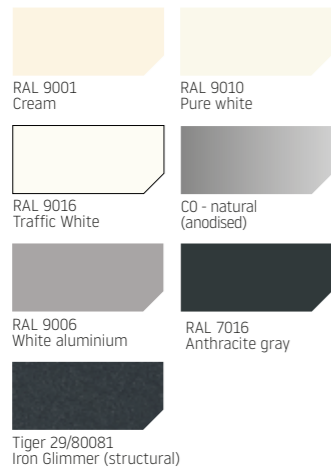

	RAL 9001 Cream	RAL 9010 Pure white	RAL 9016 Traffic White	CO - natural (anodised)	RAL 9006 White aluminium	RAL 7016 Anthracite gray	Tiger 29/80081 Iron Glimmer (structural)
Screen 75	•	•	•	•	•	•	•
Screen 85 45°	•	•	•	•	•	•	•
Screen 85 half-round	•	•	•	•	•	•	•
Screen 85 square	•	•	•	•	•	•	•
Screen 95 45°	•	•	•	•	•	•	•
Screen 95 square	•	•	•	•	•	•	•
Screen 95 square	•	•	•	•	•	•	•
Screen 105 45°	•	•	•	•	•	•	•
Screen 105 square	•	•	•	•	•	•	•
Screen 120 half-round	•	•	•	•	•	•	•
Screen 120 closed	•	•	•	•	•	•	•
Screen 125 45°	•	•	•	•	•	•	•
Screen 125 square	•	•	•	•	•	•	•



Your supplier of sun protection systems

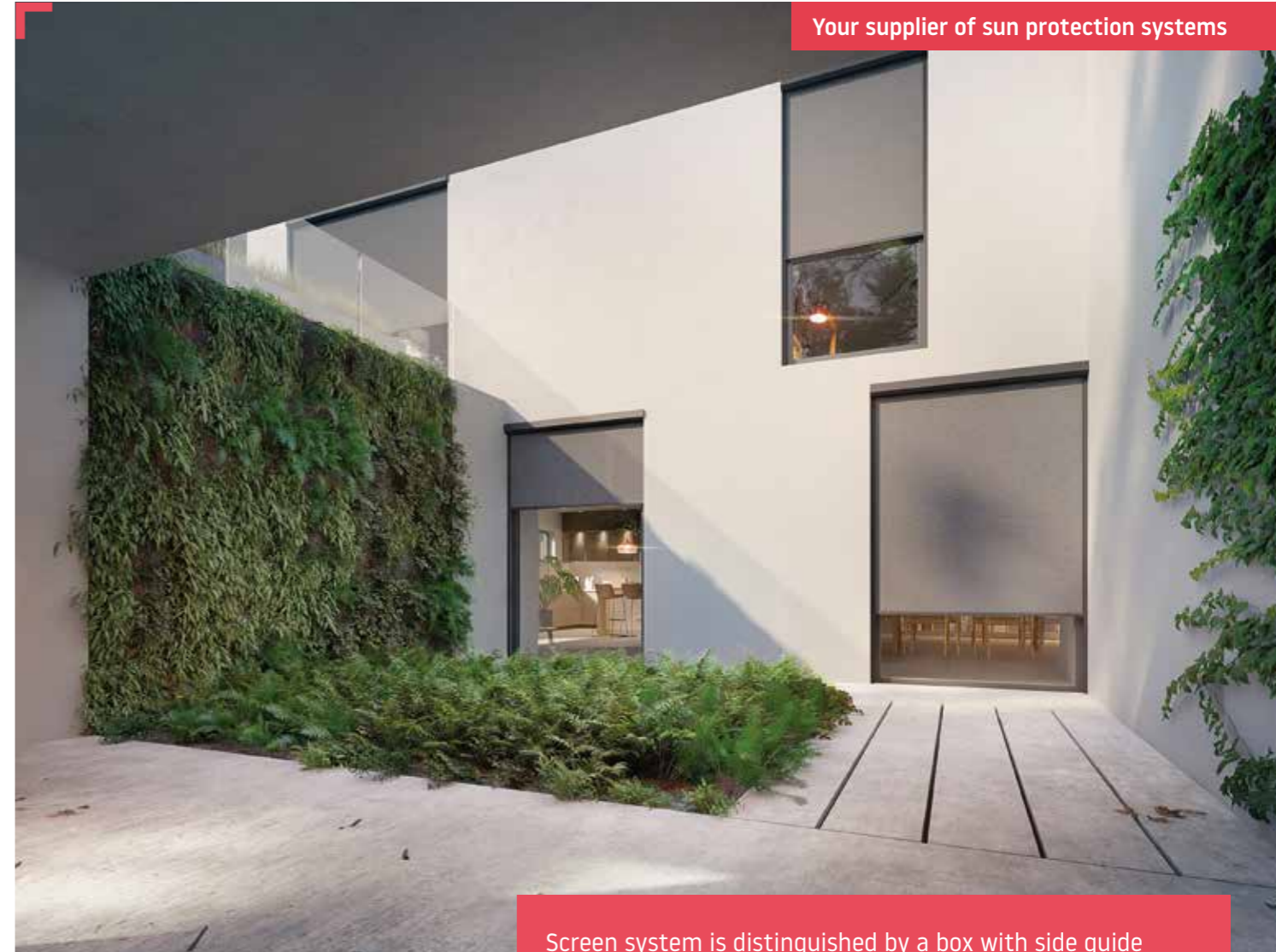

Screen

Screen system is distinguished by a box with side guide rails, integrated with a PVC or fibreglass fabric, which is durable and resistant to weather conditions such as gusty wind, hail, or rain.

Moreover, thanks to the properties of the used fabrics, they guarantee visual comfort inside the building - on the one hand, they do not give the effect of darkening and on the other hand, they suppress the penetration of intense sunlight.

We offer a wide range of shapes and colours of boxes and guide rails, as well as a wide range of fabric types, in order to optimally match the facade of the building.



Screen 75 45°

Screen 75 45°

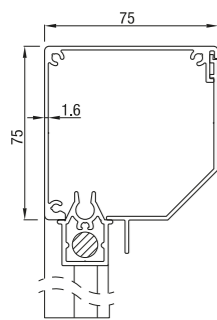

end slat

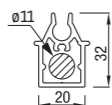

	Maximum width (cm)	height (cm)	area (m ²)
Screen 75 45°	350	230	5,8

Screen 85

Screen 85 45°

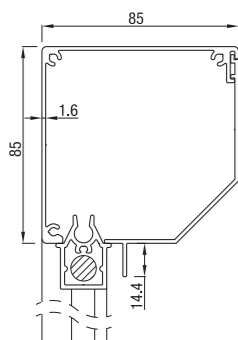

Screen 85 half-round

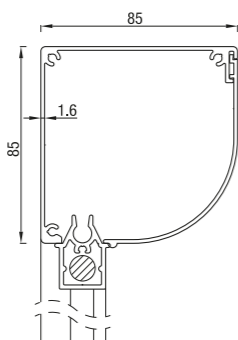

Screen 85 square

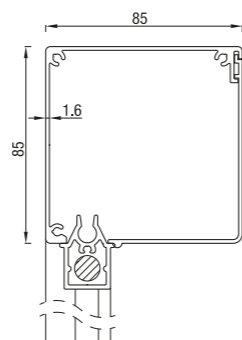

end slat

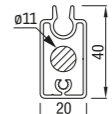
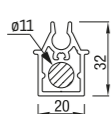

	Maximum width (cm)	height (cm)	area (m ²)
Screen 85	350	320	8,0

Screen 95

Screen 95 45°

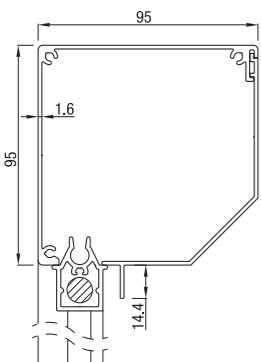

Screen 95 square

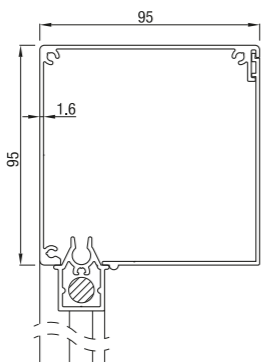

Screen 95 round

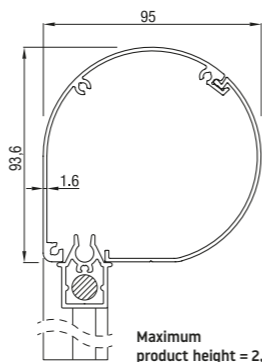

Maximum product height = 2,9 m

end slat

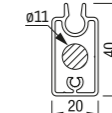
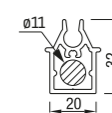

	Maximum width (cm)	height (cm)	area (m ²)
Screen 95	400	340	9,8

Screen 105

Screen 105 45°

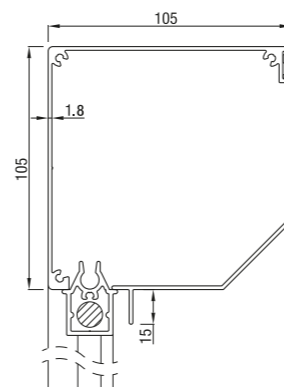

Screen 105 square

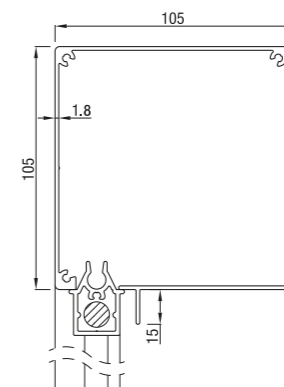

end slat

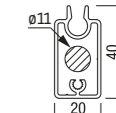
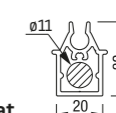

	Maximum width (cm)	height (cm)	area (m ²)
Screen 105	400	320	12,8

Screen 120 / 125

Screen 120 half-round

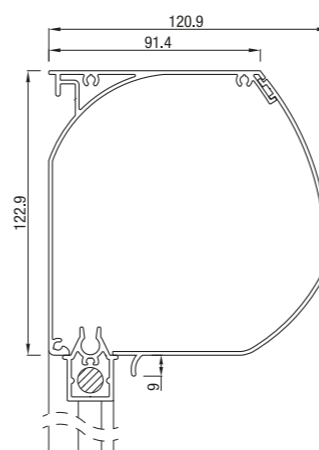

Screen 120 closed

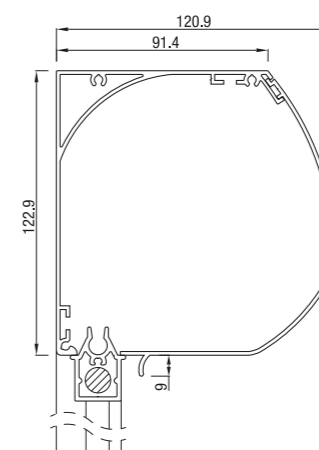

Screen 125 45°

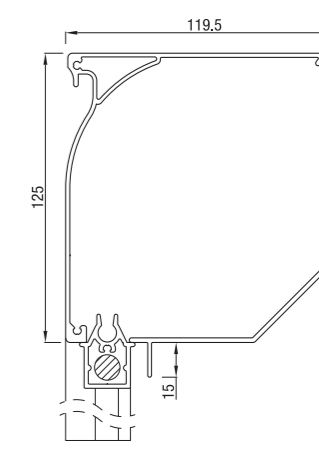

Screen 125 square

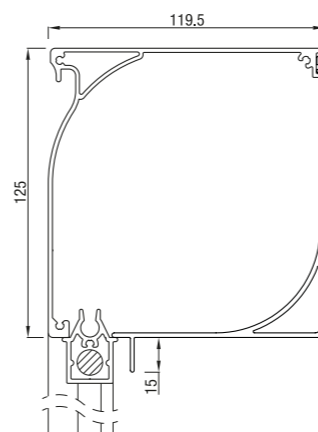

end slat

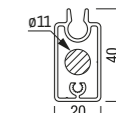
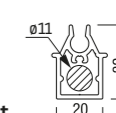

	Maximum width (cm)	height (cm)	area (m ²)
Screen 120/125	500	500	17,1