

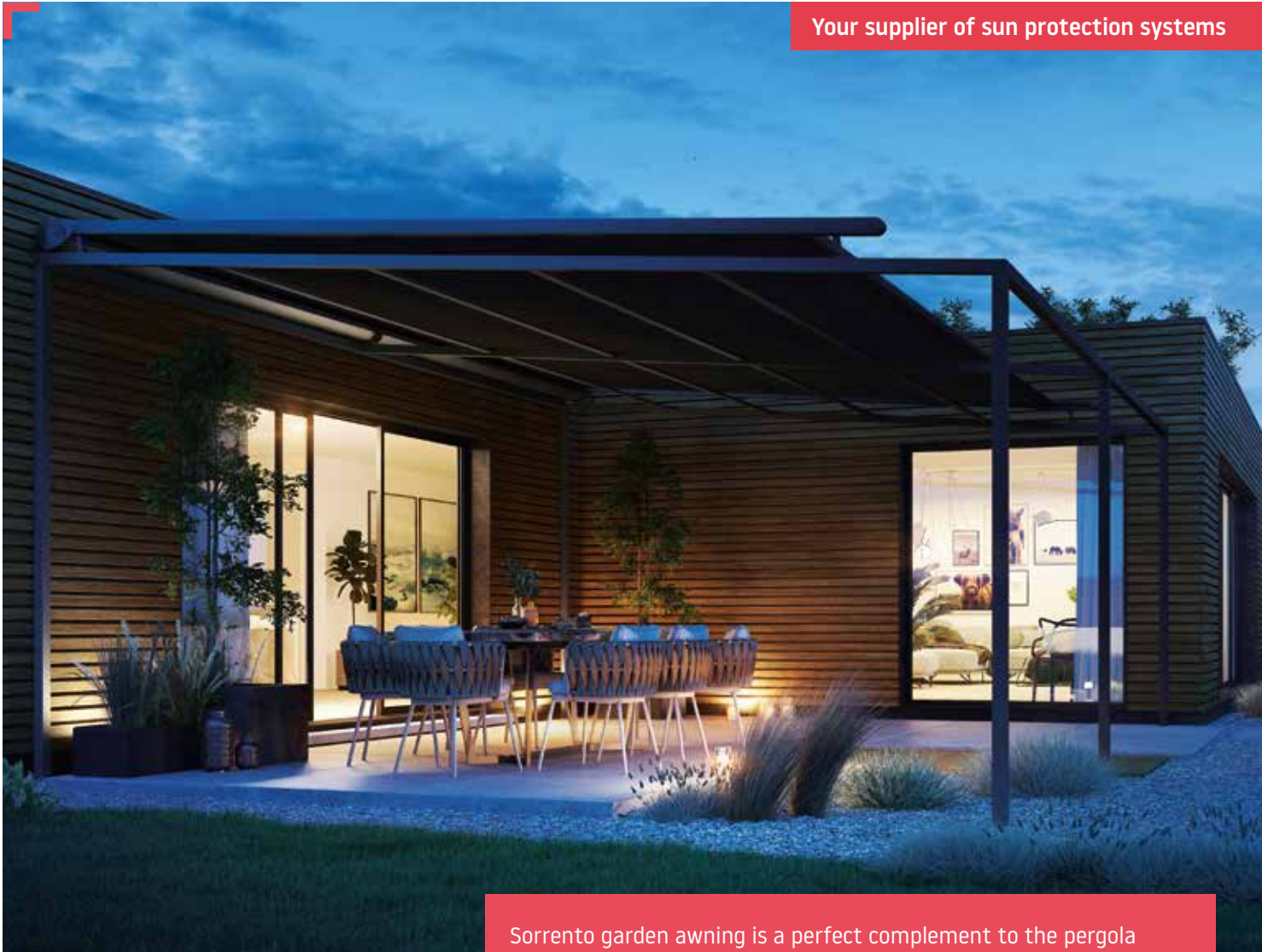

Your supplier of sun protection systems



## Sorrento

Sorrento garden awning is a perfect complement to the pergola is the , which perfectly fits the trend of roofing pergolas and terraces. It is made from high-quality aluminium alloys and has a sleek, ergonomic design. It is a must-have for anyone looking to enhance their outdoor space.

The awning also features a drainage system, which enhances its aesthetic appeal and functionality.

Sorrento system is also one of the quietest systems available on the market, thanks to the intelligent design of the Teflon seal hidden in the device's mechanism.

Sorrento Grande can be installed on the roof or under it to protect the fabric from weather conditions like rain and wind.

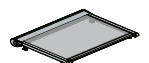
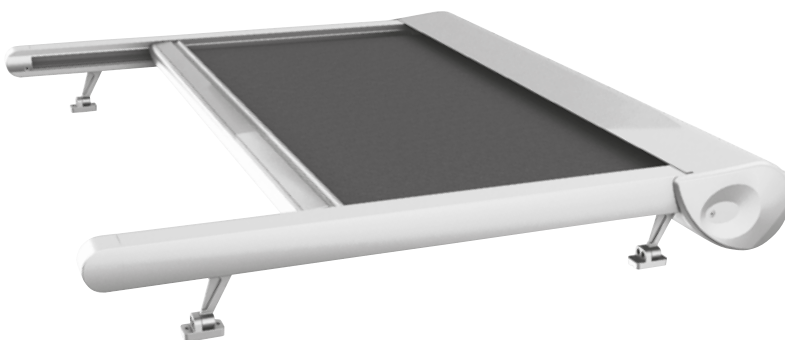

# Sorrento Grande

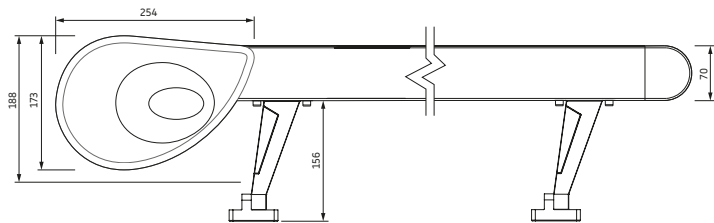

- universal use (installation on the roof or under the roof)
- structural rigidity
- silent operation (silencing system)
- maximum dimensions 5.1 x 6.0 m

## Installation

### rooftop mounting

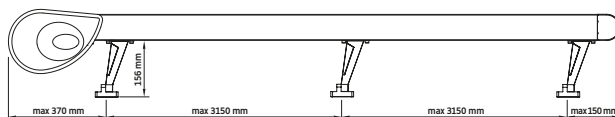

### recessed mounting (wall supports are required and will be added to the price)

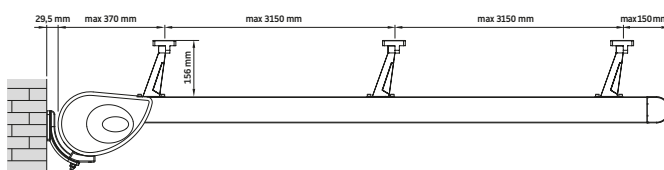

## Wall Brackets

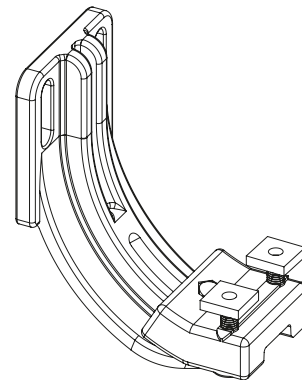

## Standard casing colours

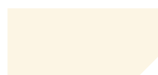

RAL 9001  
Cream



RAL 7S16  
Anthracite grey  
(structural)



RAL 7S24  
Graphite grey  
(structural)

## Sorrento Grande - coupling

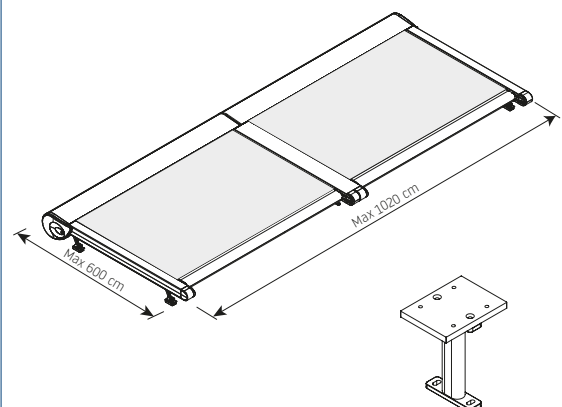

## End slat

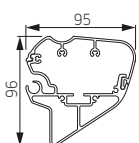

## Guide rails

